



INSTALLATION INSTRUCTIONS

Accessory
CARGO NET
 P/N 08L96-SHJ-100

Application
2009 ODYSSEY

Publications No.
All 40227
 Issue Date
AUG 2008

Put this information in the glove box with the vehicle owner's manual.

PARTS LIST

Cargo net

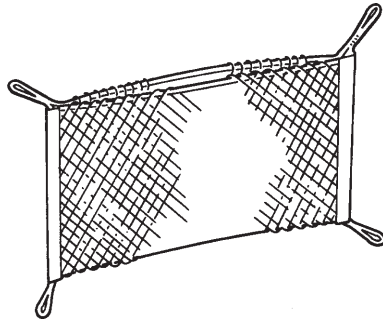

Stud screw



Anchor



TOOLS REQUIRED

Clip remover

Felt-tip pen

1. Open the tailgate and store the third row seat in the floor.

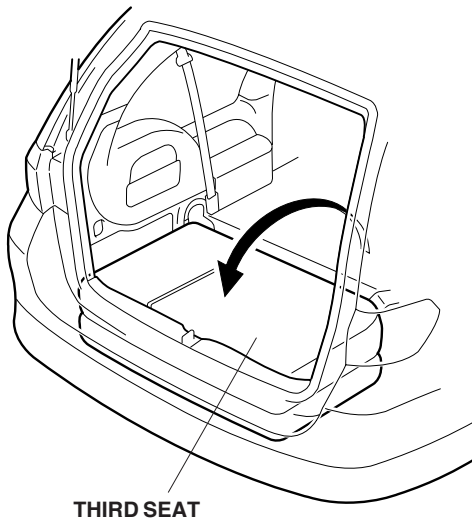

2. On each side, turn over the floor mat, and release the clip from the floor panel. Remove the clips from the resin plates on the floor mat.

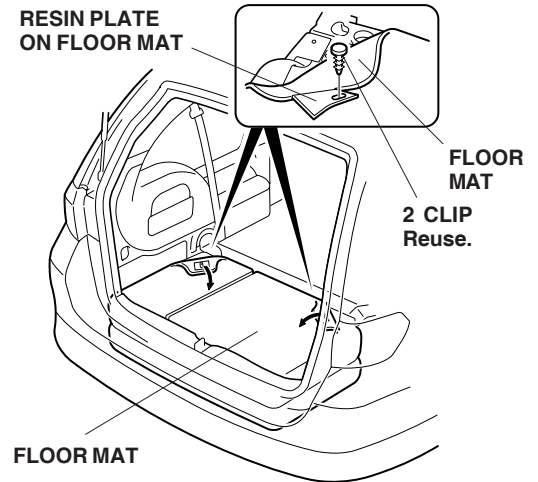

3. Turn over the floor mat. Locate the holes in the vehicle panel shown, then return the floor mat. Using a felt-tip pen, mark the floor mat at the positions of the holes.

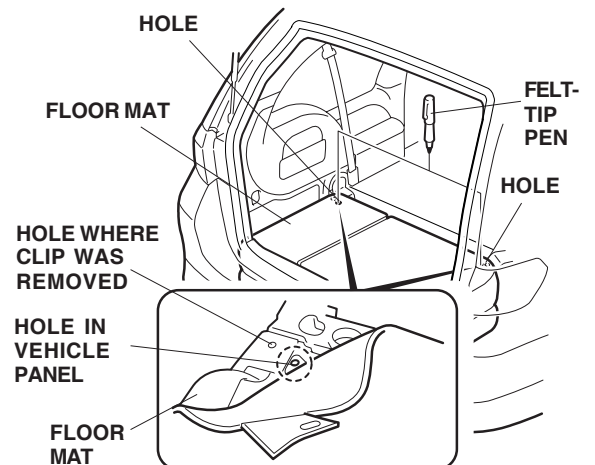

4. Reinstall the floor mat with the two clips you removed.

- Install a stud screw on each anchor. Push the stud screws through the mat at the marks you made in step 3, and secure them to the vehicle panel.

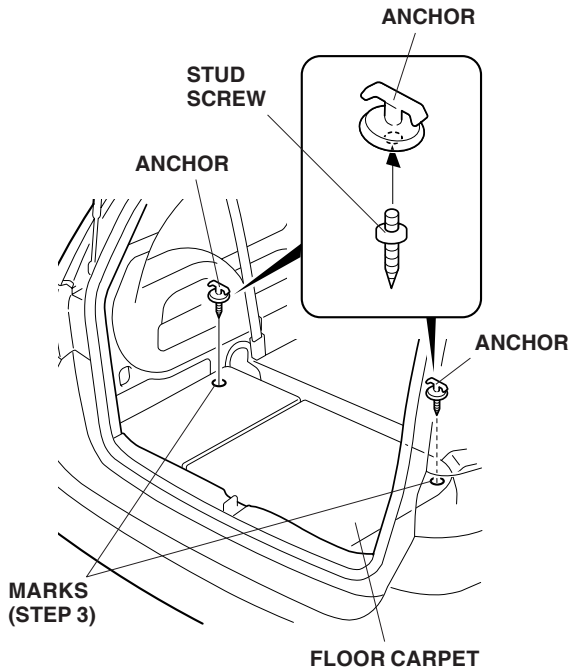

Installing the Cargo Net in the Horizontal Position

- Hook the cargo net straps to the anchors and to the vehicle hooks (lower side). Install the cargo net with the opening to the rear.

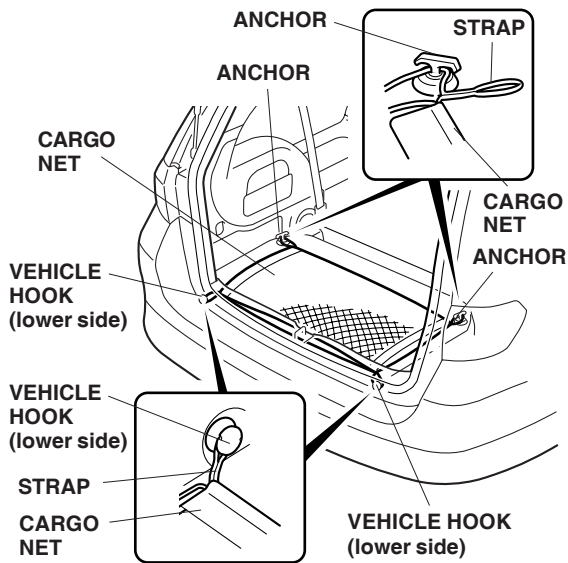

Installing the Cargo Net in the Vertical Position

- Hook the cargo net strap to the upper and lower vehicle hooks.

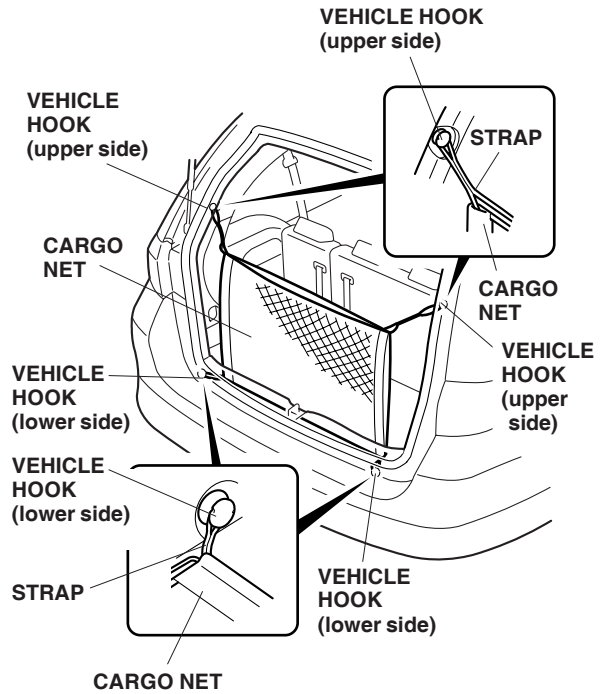

USE OF THE CARGO NET

- Some luggage stored in the cargo net may interfere with the tailgate when it is closed. To prevent damage to the cargo net, do not store large or fragile articles in the cargo net.
- Before storing articles that have sharp edges or corners, wrap them with paper or in a blanket so their sharp edges or corners will not contact the cargo net directly.