



INSTALLATION INSTRUCTIONS

Accessory
CLEAR DOOR EDGE FILMS
P/N 08P20-TK6-100

Application
2009 FIT

Publications No.
All 39858
Issue Date
AUG 2008

PARTS LIST

Left front door edge film

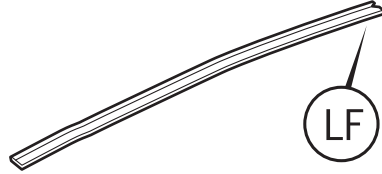

Right front door edge film

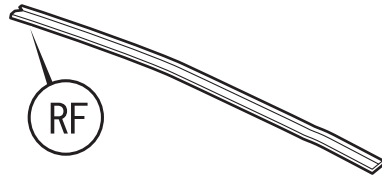

Left rear door edge film

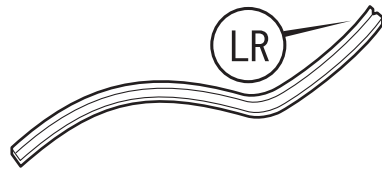

Right rear door edge film

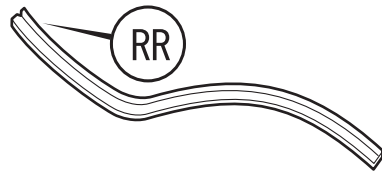

Applicator

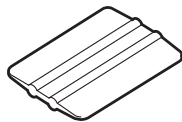

Soft sleeve

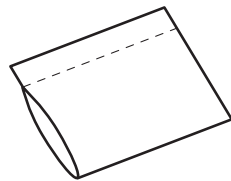

2 Alcohol swabs

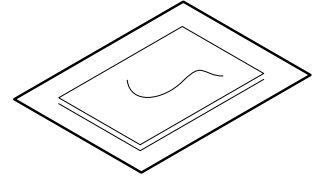

TOOLS AND SUPPLIES REQUIRED

Shop towel
Lint-free shop towel
Spray bottle
3M Protective tape application solution

INSTALLATION

NOTE:

- These instructions show the left door edge films being installed. The same procedure applies to installing the right door edge films.
- Identify each door edge film by referring to the identification marks.
- Be careful not to damage the body paint finish.
- The door edge films should be installed only if the ambient air temperature is 15°C (60°F) or above.
- To allow the adhesive to cure, do not wash the vehicle for 24 hours.

Installing the Front Door Edge Films

1. Open the left front door. Using an alcohol swab, thoroughly clean the area where the left front door edge film will attach.

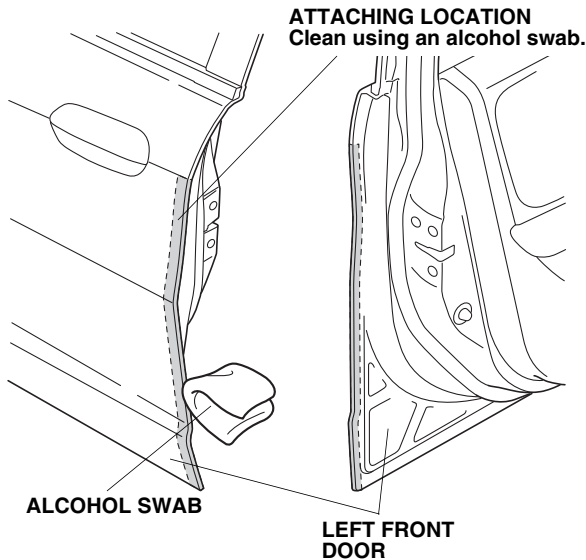

2. Close the left front door. Using a spray bottle with 3M protective tape application solution, spray the area where the left front door edge film will attach.

NOTE: Do not spray the inside the door where the door edge film will attach.

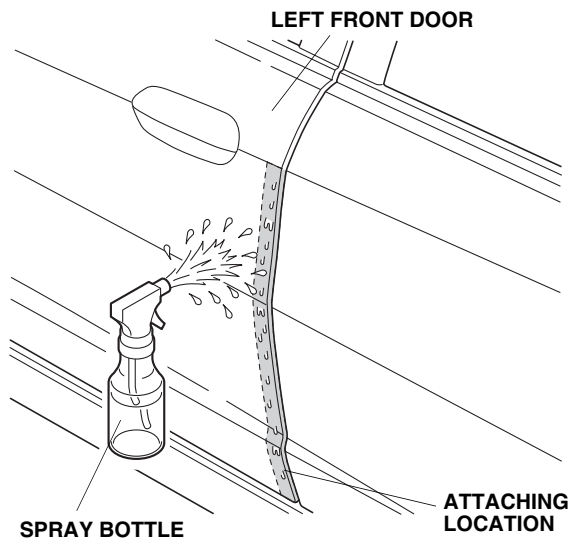

3. Open the left front door again. Peel back about 50 mm (2 in.) of adhesive backing from the left front door edge film. Align the V-notch in the door edge film with the end of the character line on the upper part of the front door.

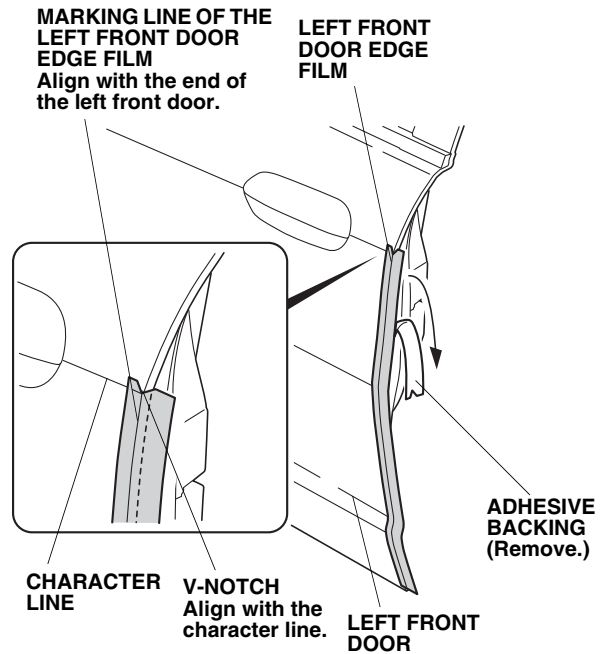

4. Continue to remove the adhesive backing while you align the center line on the door edge film with the edge of the door.
5. Insert the applicator into the soft sleeve. Starting in the middle of the door edge film and working outward, use the applicator to smooth out any bubbles from the film. To avoid lifting the film, move the applicator only in one direction.

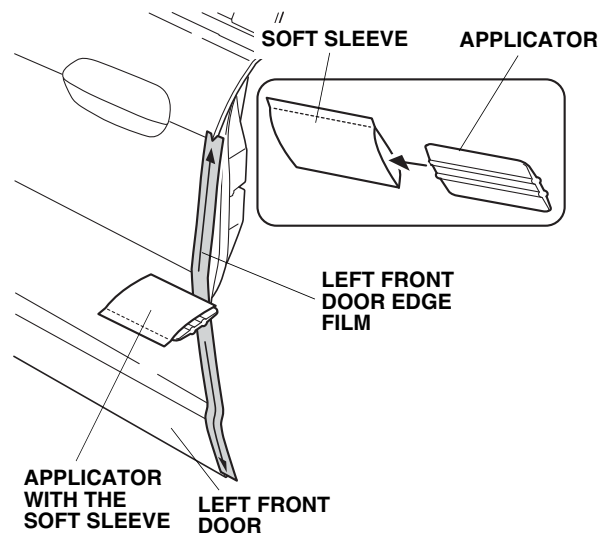

- When you are satisfied that the door film is firmly attached to the edge of the door, slowly remove the outer protective film.

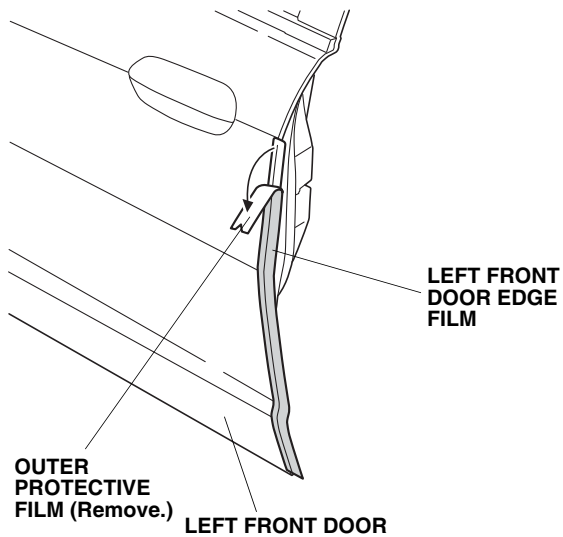

- Starting in the middle of the door edge film and working outward, fold the left front door edge film around the door edge using your fingers. Move your finger in one direction. Attach the film over the seam sealant. Do not trim or damage the seam sealant.

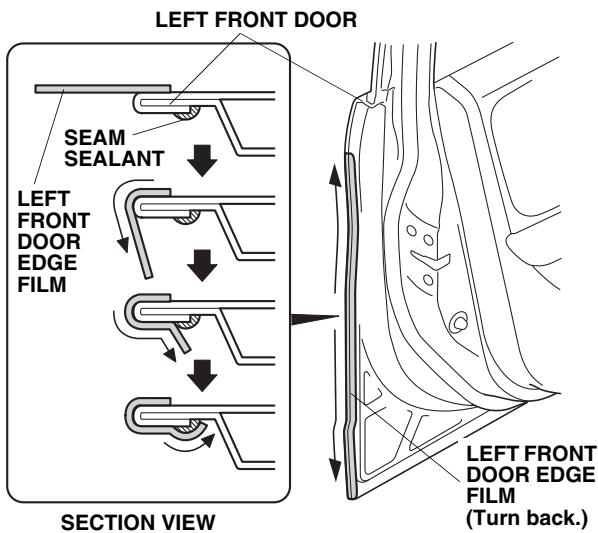

- Using a lint-free shop towel, wipe up water from the front door edge film. Allow the front door edge film to dry thoroughly.

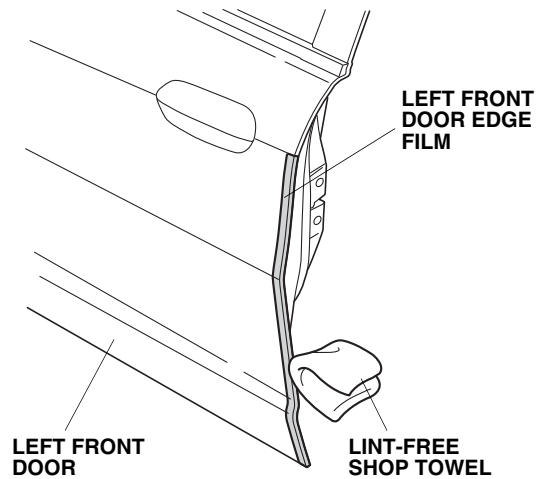

- Repeat steps 1 through 8 to install the door edge film on the right front door.

Installing the Rear Door Edge Films

- Open the left rear door. Using an alcohol swab, thoroughly clean the area where the left rear door edge film will attach.

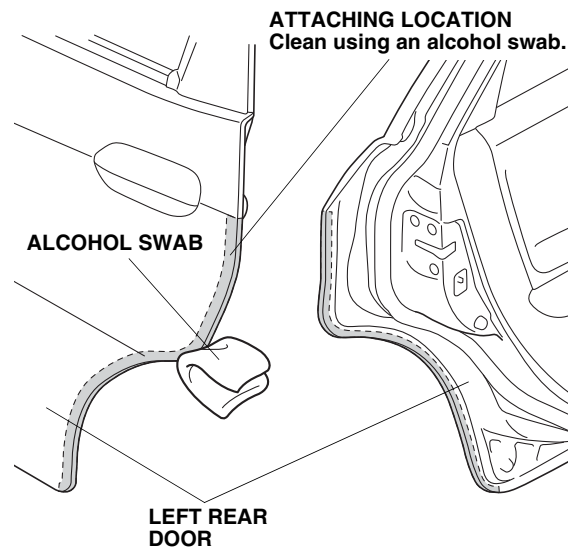

- Close the left rear door. Using a spray bottle with 3M protective tape application solution, spray the area where the left rear door edge film will attach.

NOTE: Do not spray the inside of the door where the left rear door edge film will attach.

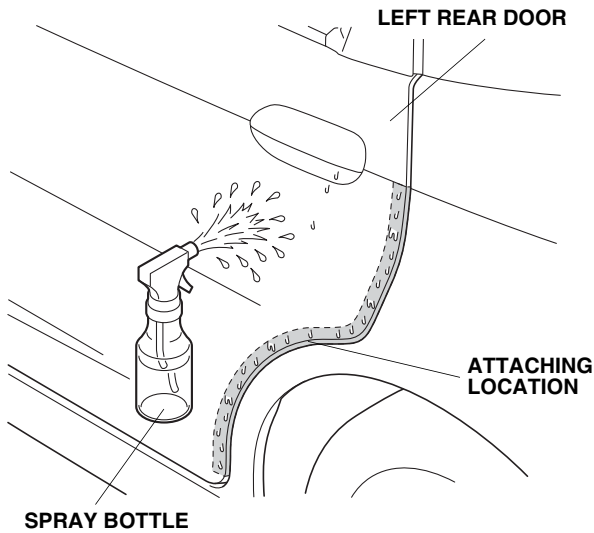

- Open the left rear door again. Peel back about 50 mm (2 in.) of adhesive backing from the left rear door edge film. Align the V-notch in the door edge film with the end of the character line on the upper part of the left rear door.

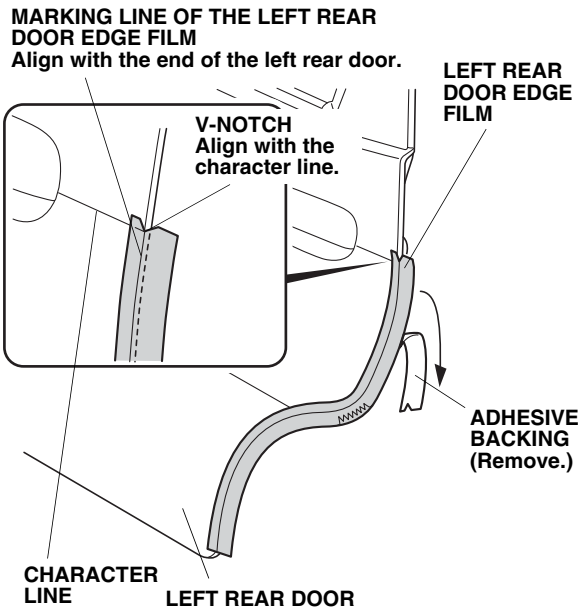

- Continue to remove the adhesive backing while you align the center line on the door edge film with the edge of the door.

- Insert the applicator into the soft sleeve. Starting in the middle of the door edge film and working outward, use the applicator to smooth out any bubbles from the film. To avoid lifting the film, move the applicator only in one direction.

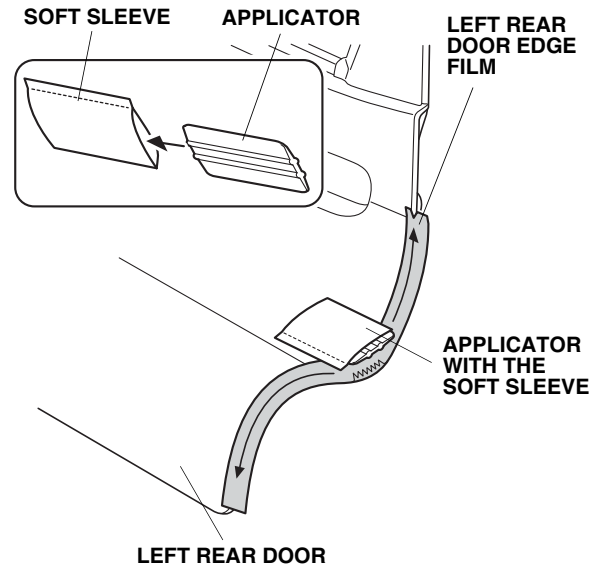

- When you are satisfied that the door edge film is firmly attached to the edge of the door, slowly remove the outer protective film.

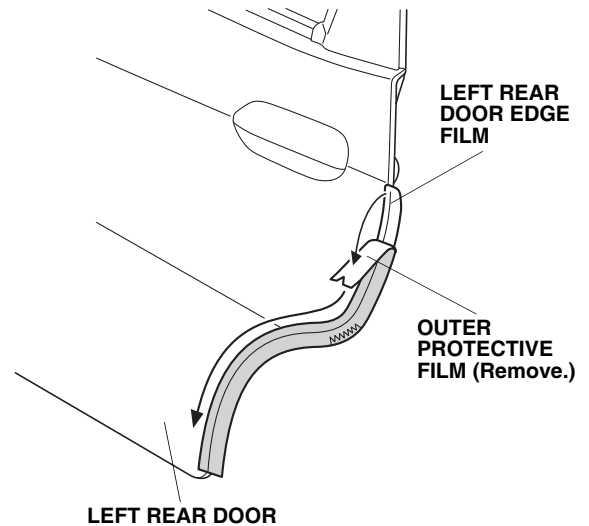

16. Starting in the middle of the door edge film and working outward, fold the door film around the door edge using your fingers. Move your finger in one direction. Attach the film over the seam sealant. Do not trim or damage the seam sealant.

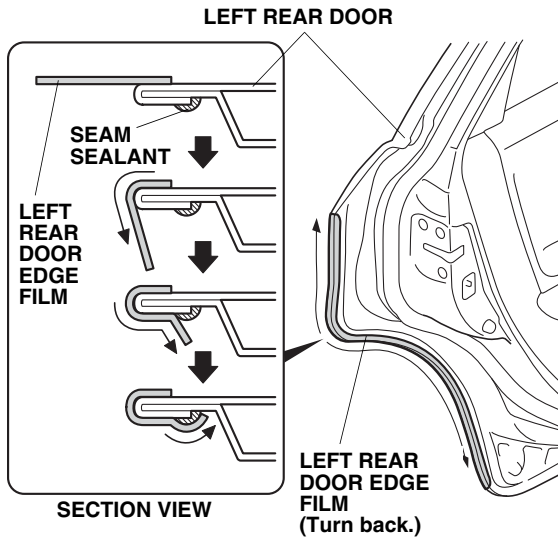

17. Using a lint-free shop towel, wipe up water from the rear door edge film. Allow the rear door edge film to dry thoroughly.

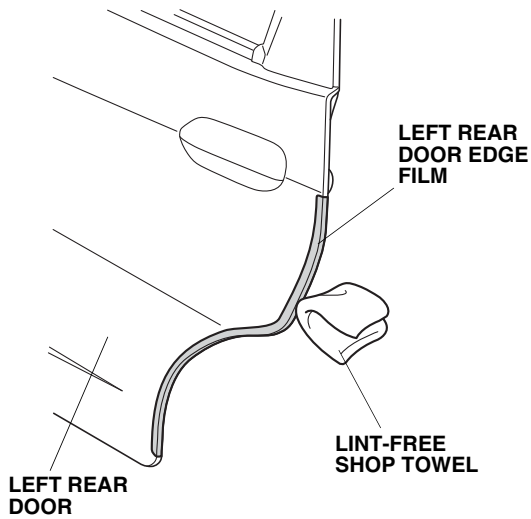

18. Repeat steps 10 through 17 to install the door edge film on the right rear door.